











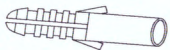



1		Φ6	X1
2		ST4X30	X6
3		Φ6x30	X6
4		M8x25	X4
5		M8x20	X4
6			X8
7			X4
8			X4
9			X2
10			X1
11			X1
12			X1
13			X2
14			X2



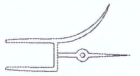

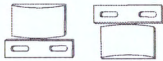
1

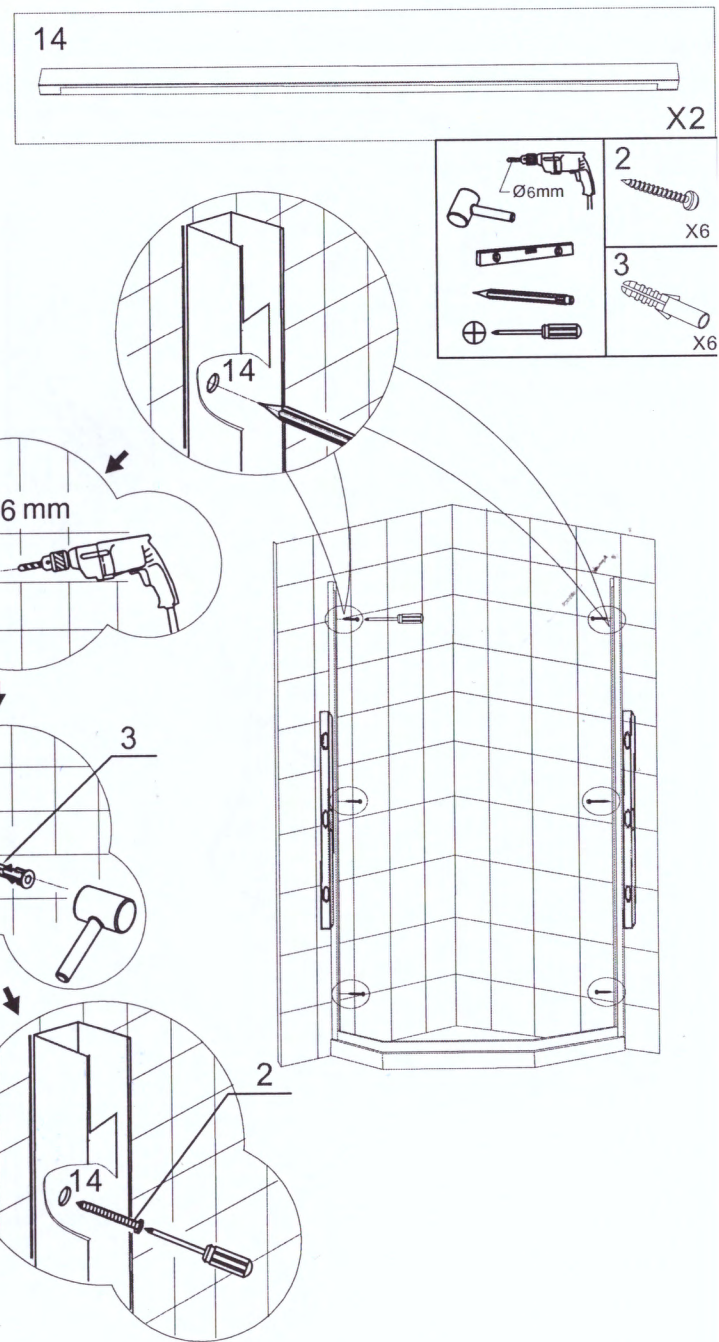
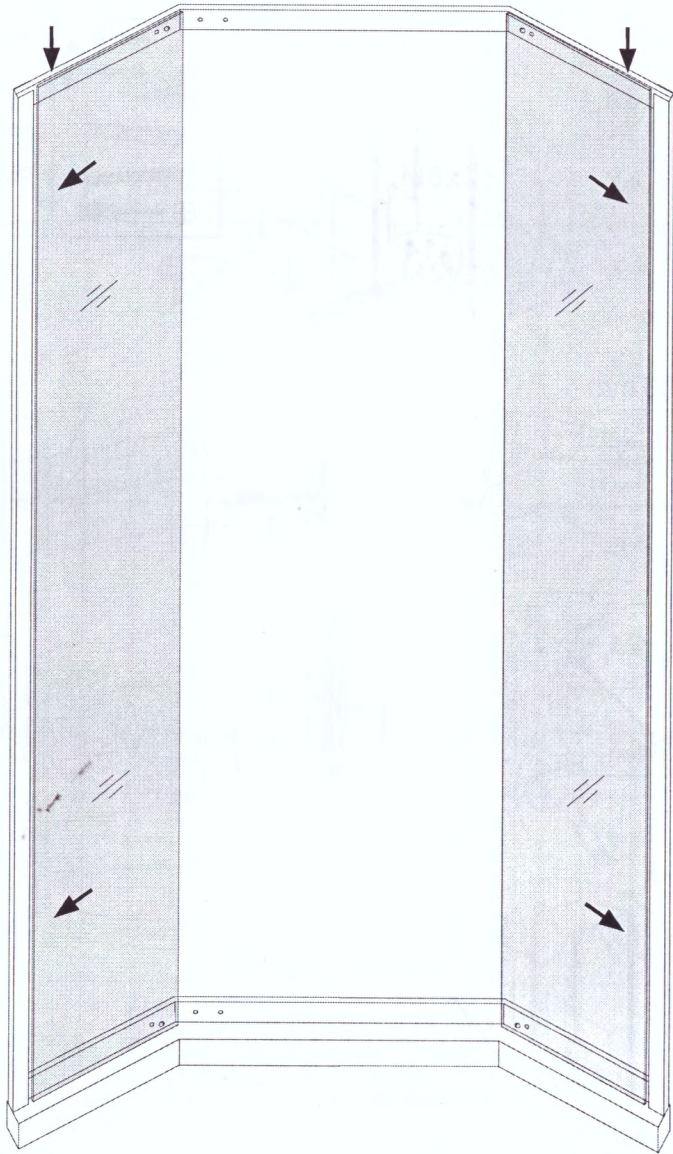

2



3

<p>4</p>  <p>X4</p>	<p>6</p>  <p>X4</p>	<p>7</p>  <p>X4</p>	<p>8</p>  <p>X4</p>	<p>13</p>  <p>X2</p>
--	--	--	--	---

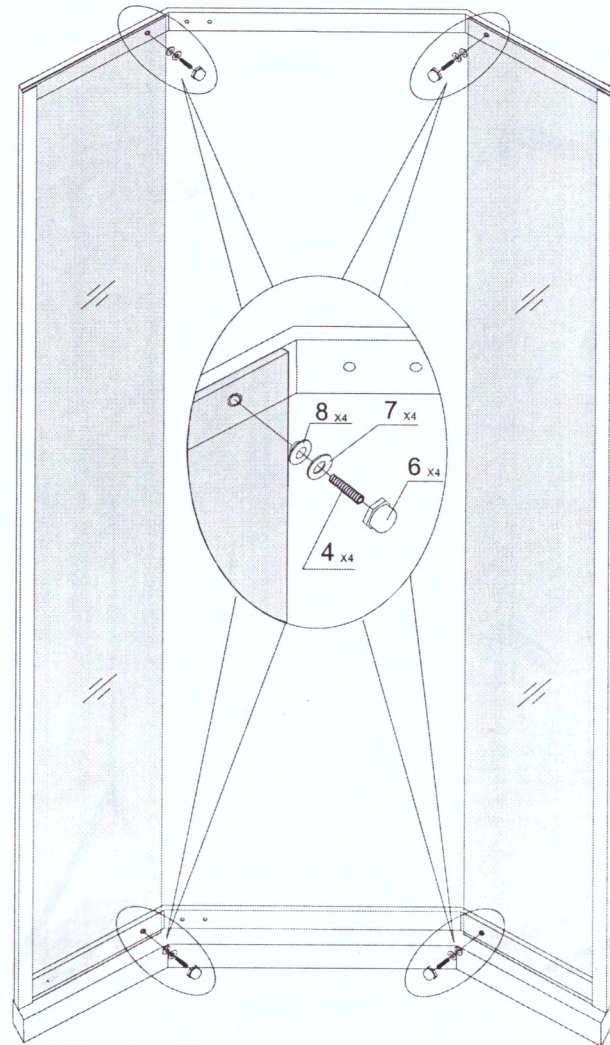

4

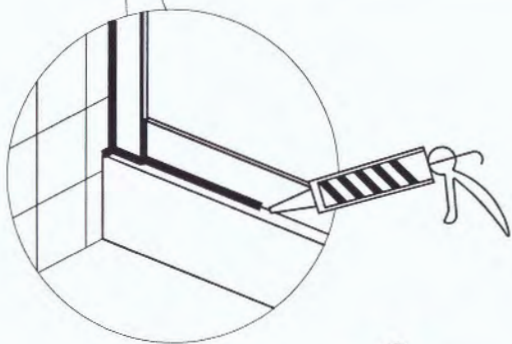
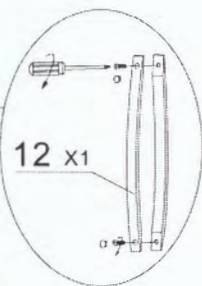
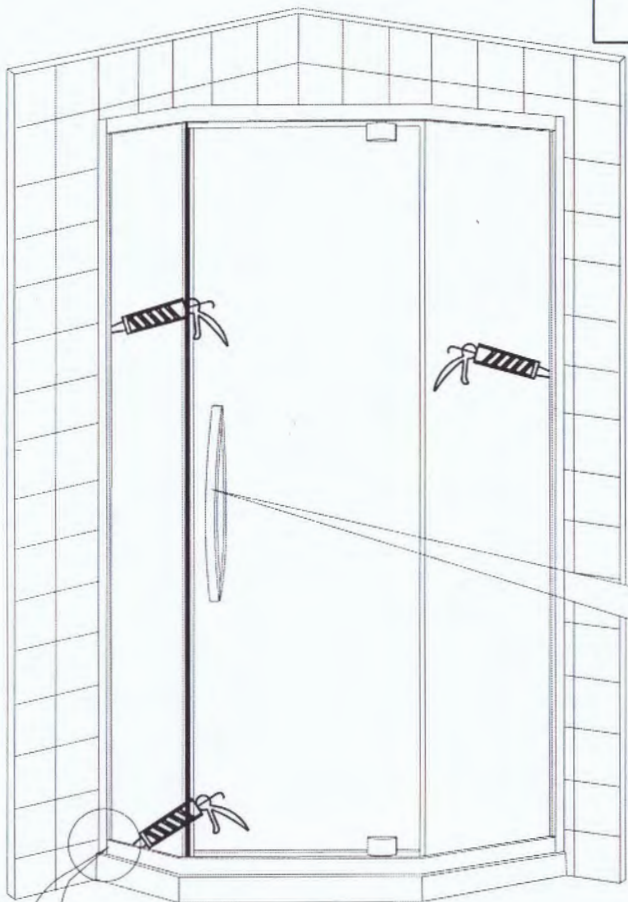

5

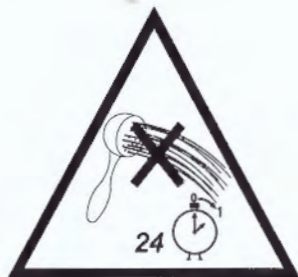

5	6	13		11	9
X4	X4	X2	X1	X1	X1

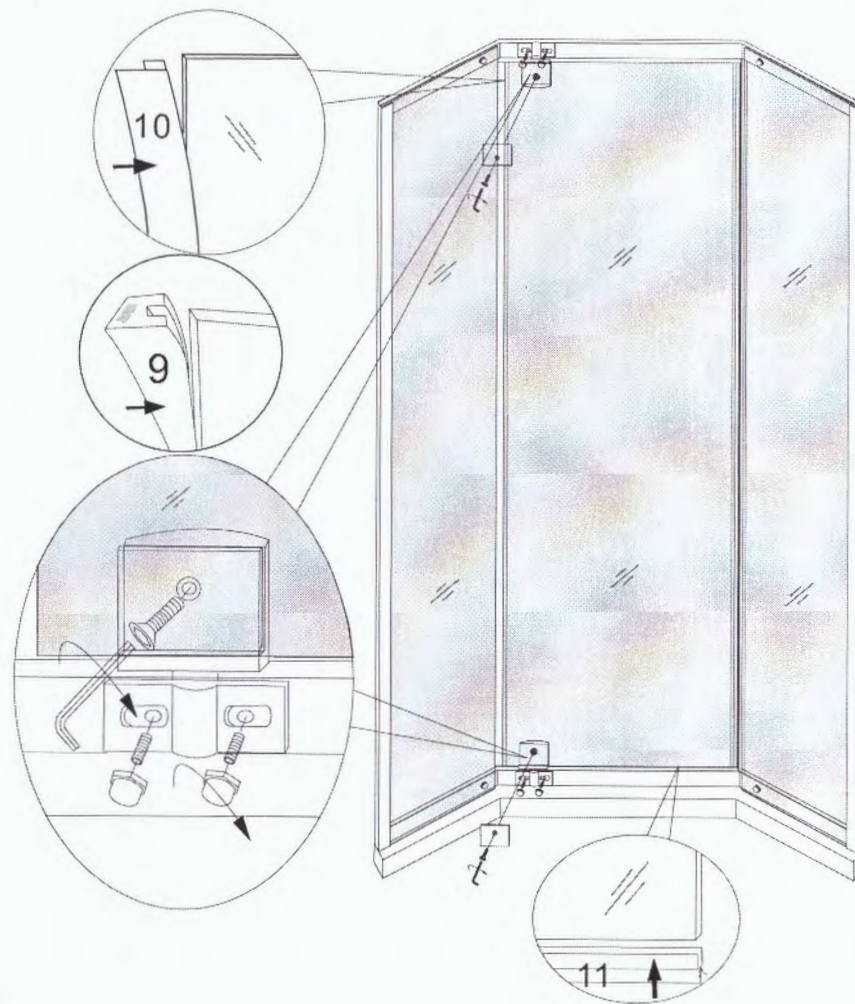

6